

# International Symposium on Micro-NanoMechatronics and Human Science (MHS) 2016

Date of Conference: 28-30 Nov. 2016

Date Added to IEEE Xplore: 19 January 2017

ISBN Information:

Electronic ISBN: 978-1-5090-2785-9 Print on Demand(PoD) ISBN: 978-1-5090-2786-6

Electronic ISSN: 2474-3771

INSPEC Accession Number: 16603961

DOI: 10.1109/MHS.2016.7824151 <https://ieeexplore.ieee.org/document/7824151>

Publisher: IEEE

Conference Location: Nagoya, Japan

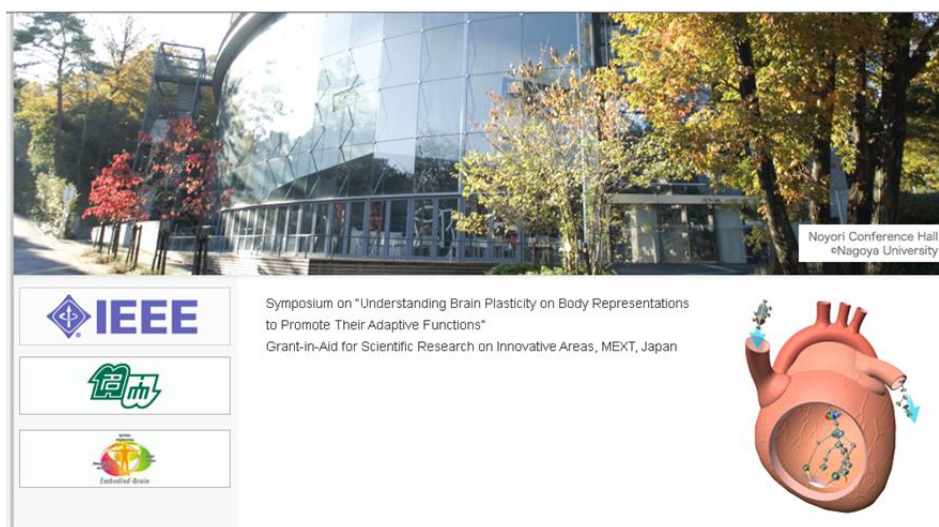

## Paper and abstract

---

### Directional Photo-Transportation on Micro Solid Particles in a Solution: A Novel Application of Visible Laser

S. Seo, H. Matsuura, K. Sadakane and K. Yoshikawa

Faculty of Life and Medical Sciences, Doshisha University, Kyoto 610-0394, Japan

“2016 International Symposium on Micro-NanoMechatronics and Human Science (MHS)”, IEEE, 2017

<https://ieeexplore.ieee.org/document/7824151>

# Directional Photo-Transportation on Micro Solid Particles in a Solution: A Novel Application of Visible Laser

S. Seo, H. Matsuura, K. Sadakane and K. Yoshikawa  
Faculty of Life and Medical Sciences, Doshisha University, Kyoto 610-0394, Japan

## Abstract

Recently, We noticed that microscopic particles of graphite move randomly in a solution containing ethanol. The motion of the graphite particles exhibits the characteristics as an active Brownian motion being different from the fluctuation under thermal equilibrium. We have tried to cause directional motion of the graphite particles by using laser. Here, we report our successful observation on the generation of directional flow with the irradiation of laser (wave length 532 nm). We will argue the mechanism of the occurrence of the vectorial motion in terms of the effect of local heating on the graphite particles.

## 1. Introduction

It is well known that micro particles move randomly in a liquid or gas due to their collision with the fast-moving atoms or molecules in the liquid or gas. Such phenomenon is known as Active Brownian motion [1]. Micro particles under Brownian motion do not have the directivity of motion due to its randomness. Laser techniques have been adopted to control objects less than micrometer such as dielectric particles [2] and living cells [3, 4]. Repulsive and attractive interactions are generated by the irradiation of laser to the objects though several mechanisms, which are optical pressure [2], radiometric force [5], surface tension gradient (Marangoni convection) [6] and so on. Photo-phoretic motion has been reported for micro particles in ambient air phase [7] and for a floating oil droplet [8].

We have found that graphite particles, which are of the order of several tens micrometer, exhibit random motion like Brownian motion in a solution containing ethanol. However, this motion of graphite particles moves actively more than Brownian motion. We adopt laser to control motion of graphite particles which move randomly. The present work is intended to establish a methodology so as to make directivity of motion from micro objects which move in the random direction.

## 2. Experimental

Graphite material and green laser (wave length 532 nm) have been adopted in the present work. Figure 1 shows graphite particles observed by microscope of which are of the order of several tens micro meter. The power of laser has been set at 0.2 W. Shown in Fig. 2 is the schematic diagrams

of the experimental setup, which consist of the laser system, a container and a sample dish. The container has been backfilled with a solution containing 99.5 % ethanol of 12 ml and graphite material of 0.02 g. The container is in the form of circular column with the diameter of 30 mm and the sample dish backfilled with ethanol solution containing graphite material is 10 mm in diameter and 2 mm in depth. Graphite fragments have been dispersed in the sample dish. Motion of graphite particles have been monitored by a distal microscope.

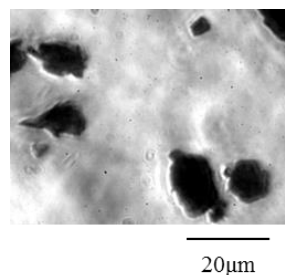

Fig. 1 Image of graphite particles observed by microscope.

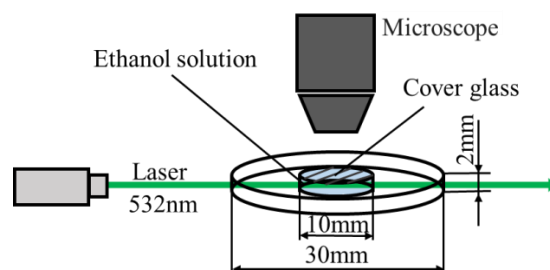

Fig. 2 Schematic diagram of the experimental set up for the observation of disperse solution of graphite particles.

## 3. Results and Discussion

Figure 3 shows snapshots on motion of graphite particles in the ethanol solution due to the irradiation of laser of which wave length is 532 nm. The experimental results have indicated that graphite particles move along with the incident direction of laser. We consider that the heating of each graphite particles by the irradiation of laser lead to the directional motion of graphite particles, which is similar to the mechanism of radio meter. The mechanism is as follows: surface of each graphite particles is heated locally by laser. Then, molecules of solution around each fragments obtain kinetic energy by attaching the heated surfaces of the particles and leave the surfaces with momentum which correspond to the obtained energy. Each graphite particles

move in the opposite direction of the molecules according to law of action and reaction.

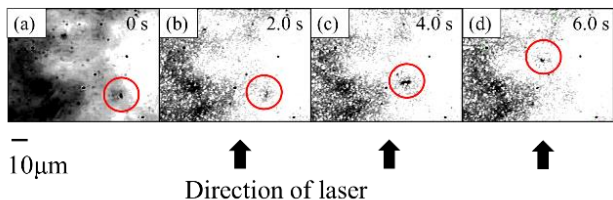

Fig.3 Snapshots on motion of a graphite particle due to the irradiation of laser. Arrays in black indicate the incident direction of laser.

Figure 4 show a snapshot of moving graphite particles in the solution containing ethanol of 99.5 %, together with arrays which indicate velocities of each particles. Graphite particles move randomly like Brownian motion. However, each particle is intensity compared with Brownian motion. Notice that this phenomenon on graphite particles take place spontaneously in the solution of ethanol. Based on observed data, maximum velocity of graphite particles is estimated by around 0.3 mm/s.

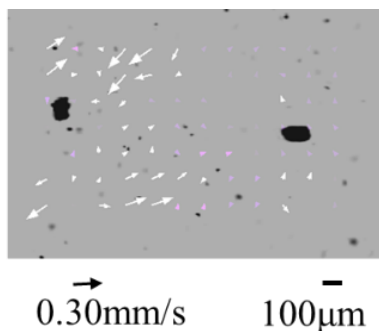

Fig. 4 Snapshot of motion of graphite particles in the solution of 99.5% ethanol. Arrays in white indicate velocities of each particles.

Shown in Fig. 5 are schematic diagram of experimental set up on side and slanted view. The container is 65 mm in width, 35 mm in depth and 5 mm in height. Graphite particles have been dispersed in the container. Motion of graphite particles have been recorded by a CCD video camera with 30 frames per second.

Figure 6 (a) shows the side views of the container backfilled with the ethanol solution containing graphite material after 2.6 s later from the beginning of the irradiation. Green laser with input power of 0.2 W have been irradiated from the left hand side of the container. The incident height of laser is 3 mm from the bottom of container. Observed velocities of graphite fragments have indicated as arrays in white as shown in Fig. 6 (b). The experimental results have indicated that graphite particle existed above the laser beam move along with the incident direction of laser. Meanwhile, graphite particles below the laser beam move opposite direction against the incident direction of laser. We have calculated maximum velocity of

graphite particles as 3.1 mm/s from experimental results. Intermittently, although graphite particles move randomly in the solution without the irradiation of laser, graphite particles move forward or backward directions against the incident direction of laser when graphite particles are subjected to the irradiation of laser. This mean that the direction on motion of graphite particles can be controlled by the irradiation of laser. The maximum velocity of graphite particles irradiated by laser is an order of magnitude larger than that without the irradiation of laser.

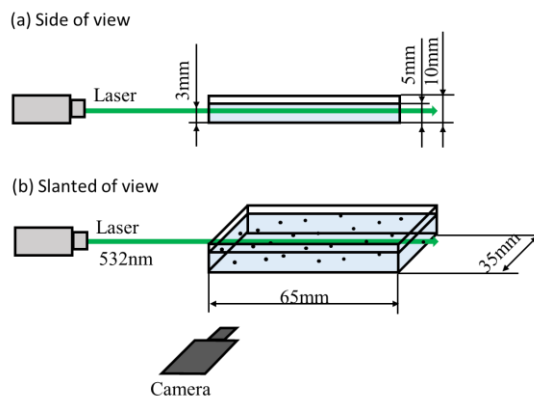

Fig. 5 Schematic diagrams of the experimental set up for the observation on denser graphite solution. (a) Side view. (b) Bird view.

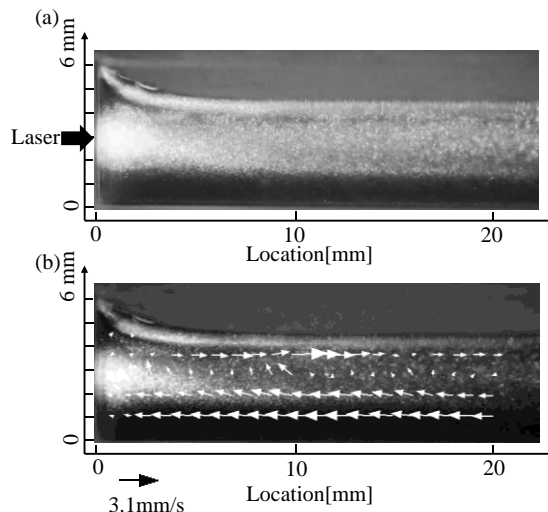

Fig. 6 Side views of motion of graphite particles caused by the laser irradiation after 2.6 s from the beginning of irradiation. (a) Snapshot of moving graphite fragments. Arrow in black indicates the direction and point of incidence of laser. (b) Arrays in white indicate velocities of graphite particles.

The lower figure of Fig. 7 is spatio-temporal diagram up to 10 s from the beginning of the irradiation of laser, which is illustrating the motion of graphite particles existed above 1 mm in height measured from the laser beam. Each slopes of lines in white of the diagram describe velocities of each particle. The diagram has indicated that graphite particles

move instantly after the irradiation of laser along with the direction of incident laser.

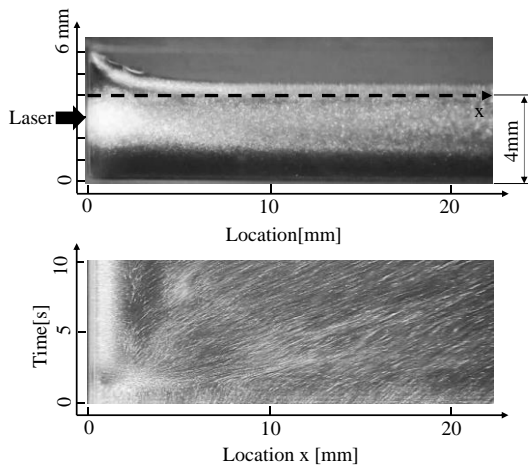

Fig. 7 Below image is spatio-temporal diagram of motion of graphite particles. The spatio-temporal diagram represents velocities of graphite particles existing above 1 mm in height against the laser beam illustrated by broken line in black. The position of incidence on laser is 3 mm in height indicated by the black arrow. The average flow velocity is 2.3mm/s.

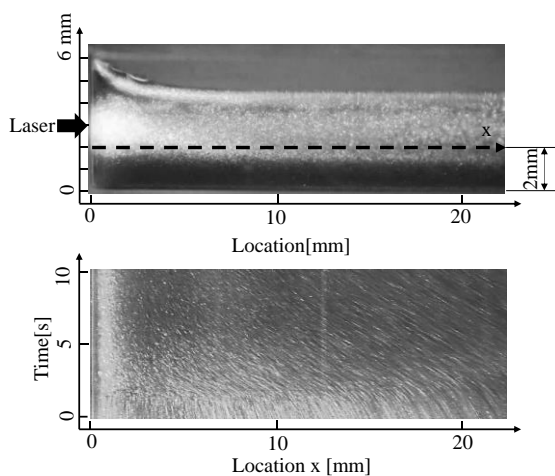

Fig.8 Below image is spatio-temporal diagram of motion of graphite particles. The spatio-temporal diagram represents velocities of graphite particles existing below 1 mm in height against the laser beam illustrated by broken line in black. The position of incidence on laser is 3 mm in height indicated by the black arrow. The average flow velocity is 1.2mm/s.

The spatio-temporal diagram of Fig. 8 has indicated velocities of graphite particles exist below 1 mm in height for the laser beam up to 10 s. The graphite fragments move opposite direction of the incident direction of laser. The velocity is slower than above 1 mm in height for the laser.

#### 4. Conclusion

We have found that microscopic graphite particles dispersed in solution containing ethanol move spontaneously in the random direction like Brownian motion. However,

graphite particles move actively compared with Brownian motion. Based on experimental results, motion of the graphite particles in the forward and backward direction of incident direction of laser are constructed by the irradiation of laser. Maximum velocity of graphite particles irradiated by laser is around ten times faster than that without the irradiation of laser. The further studies are awaited to make clear the mechanisms on random motion of graphite particles in ethanol solution and vectorial flow along the incident direction of laser. It is our expectation that these findings provide fundamental understanding on the behavior of microscopic particles in a liquid solution and methodology to control of such micro particles adopted by laser.

#### Reference

- [1] A. Ashkin, J. M. Dziedzic, J. E. Bjorkholm, and S. Chu, *Opt. Lett.* 11, 288 (1986).
- [2] Einstein, Albert, "Investigations on the Theory of the Brownian Movement", Dover Publications. Retrieved 2013-12-25 (1956) [Republication of the original 1926 translation].
- [3] S. Bayouduh, T.A. Nieminen, N.R. Heckenberg, H. Rubinsztein-Dunlop, "Orientation of biological cells using plane-polarized Gaussian beam optical tweezers", *J. Modern Opt.* 50 1581–1590 (2003).
- [4] S. Hashimoto, A. Yoshida, T. Ohta, H. Taniguchi, K. Sadakane, K. Yoshikawa, Formation of Stable Cell-Cell Contact without a Solid/Gel Scaffold: Non-invasive Manipulation by Laser under Depletion Interaction with a Polymer", *Chem. Phys. Lett.*, 655 - 656, 11-16 (2016).
- [5] P. C. Ke and M. Gu, *Appl. Opt.* 38, 160 (1999).
- [6] M. F. Schatz and G. P. Neitzel, *Annu. Rev. Fluid Mech.* 33, 93 (2001).
- [7] S. N. Watanabe, et al., "Negative photophoresis of smoke particles observed under microgravity", *Chem. Phys. Lett.*, 511, 447 (2011).
- [8] S. Rybalko, et al., "Forward and backward laser-guided motion of an oil droplet", *Phys. Rev. E*, 70, 046301 (2004)

# Directional Photo-Transportation on Micro Solid Particles in a Solution: A Novel Application of Visible Laser

*S. Seo, H. Matsuura, K. Sadakane and K. Yoshikawa*  
Faculty of Life and Medical Sciences, Doshisha University

Recently, We noticed that microscopic particles of graphite move randomly in a solution containing ethanol. The motion of the graphite particles exhibits the characteristics as an active Brownian motion being different from the fluctuation under thermal equilibrium. We have tried to cause directional motion of the graphite particles by using laser. Here, we report our successful observation on the generation of directional flow with the irradiation of laser (wave length 532 nm). We will argue the mechanism of the occurrence of the vectorial motion in terms of the effect of local heating on the graphite particles.

